

PATRIZIAGARGANTI

Firenze

**BESPOKE
LIGHTING
DESIGN**











Bespoke Lighting Design 02

design Roberto Lazzeroni

Holly collection

25 lights 3 units Chandelier

* All the chandeliers can be made at your pleasure with the following diameters:
cm 135 (20 lights), cm 73 (10 lights), cm 40 (5 lights).

| Finish chandelier structure | Half-shade versions | | | | | | | | |
|---|---|---|---|---|---|--|---|---|--|
| |  |  |  |  |  |  |  |  | |
|  | H03G1 | H03G2 | H03G3 | H03G8 | H03G4 | H03G5 | H03G6 | H03G7 | |
|  | H03K1 | H03K2 | H03K3 | H03K8 | H03K4 | H03K5 | H03K6 | H03K7 | |
|  | H03C1 | H03C2 | H03C3 | H03C8 | H03C4 | H03C5 | H03C6 | H03C7 | |
| Weight with pearls weave half-shade Kg 18,8 | | | | Weight with silk half-shade Kg 13 | | | | | |

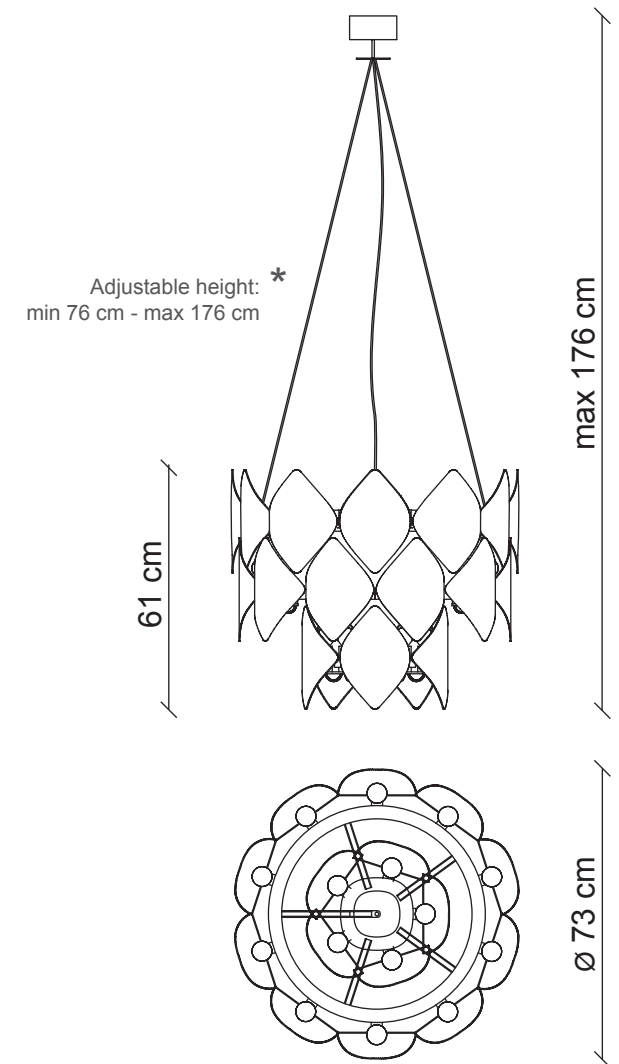

L. 18x8 cm
H. 25 cm



25x
40W E14
not supplied

m³ 0,43