

PATRIZIAGARGANTI

Firenze

**BESPOKE
LIGHTING
DESIGN**









Bespoke Lighting Design 02

design Roberto Lazzeroni

Holly collection

10 lights 1 unit Chandelier

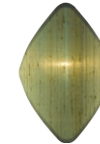
* All the chandeliers can be made at your pleasure with the following diameters:
cm 135 (20 lights), cm 73 (10 lights), cm 40 (5 lights).

Finish chandelier structure	Half-shade versions								
									
	H18G1	H18G2	H18G3	H18G8	H18G4	H18G5	H18G6	H18G7	
	H18K1	H18K2	H18K3	H18K8	H18K4	H18K5	H18K6	H18K7	
	H18C1	H18C2	H18C3	H18C8	H18C4	H18C5	H18C6	H18C7	
Weight with pearls weave half-shade Kg 7,5				Weight with silk half-shade Kg 5,3					

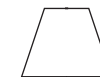
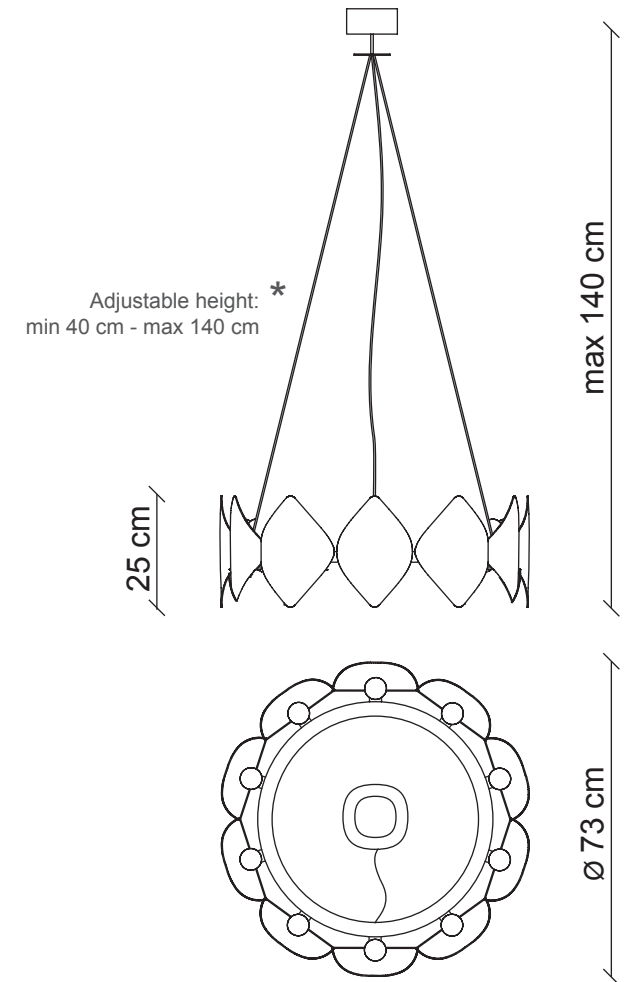

L. 18x8 cm
H. 25 cm



10x
40W E14
not supplied

m³ 0,27